

**Sumner County Schools Conventional Special Education School Bus Specifications**

Quantity: 6

**Notes to Bidder:**

1. Bidder must have a fully licensed in-state sales and service facility. **State Dealer License # is** \_\_\_\_\_
2. Salesman's dealer license # is \_\_\_\_\_
3. You must return a copy of these specs with your bid response noting all exceptions and deviations.
4. Factory direct deliveries are not acceptable, product must have a pre-delivery inspection at in-state facility.
5. Please state earliest delivery date: \_\_\_\_\_

**Equipment**

**Description**

**YES**

**List Exception**

Bus Type

Conventional w/ Lift

TN Specifications

Must meet all state and federal school bus requirements

Engine location

Front

Year Model

New model 2020 or newer

Seating Capacity

36 + 4 wheel Chairs with continous track tie downs and Safeguard Safety Seats - See Attached Floor Plan

Delivery

1500 Airport Rd, Gallatin, TN 37066

Manuals

Include owners manual

Service Training

Provide a minimum of 12 hours product service training at no charge for body and chassis components @ SCS

Warranty-Body

Please Specify Warranty

**CHASSIS**

**CHASSIS**

Axle Ratio

5.29 or greater or 65mph road speed

Air Compressor

18.7 CFM, minimum

Air dryer

Merator Wabco SS 1200 - parts # 5400850-7010 or Bendix AD-9 w/ heater

Air tanks

3,790 or greater cubic inch capacity, Bendix DV-2 with Heater

Alternator

275 or greater amp, Delco or Leece Neville equivalent

Axle , front

10,000 lbs. minimum with oil bath with synthetic lube

Axle, rear	21,000 minimum lbs. with synthetic lube		
Batteries	3- 1950 cca 31 Series		
Battery Emgey Disconnect	Factory Installed in Battery Department		
Block Heater	750 watt with bumper mounted recepticle		
Brakes	Outboard drum type w/ auto slack adjusters		
Brakes	ABS with diagnostic light in dash		
Brakes, front	16.5" x 5" minimum		
Brakes, rear	16.5" x 7" minimum		
Bumper 3/16" steel, front	12" with crossing control arm and stowage bracket		
Bumper 3/16" steel, rear	Concave design		
Cooling system	Radiator to have at least 620 square inches		
Driveline	Guards around each shaft		
Engine Rating	220 HP. Minimum		
Engine Type	Inline 6 cylinder diesel, Cummins ISB, no exceptions		
Exhaust	Below rear bumper or left side bumper with exhaust mitigator		
Frame	50,000 lbs. psi with rear mounted tow hooks		
Fuel filter	Fuel Water Separator/ Cartridge type at the engine		
Fuel /Water separator	Davco 382-C with heater or Fleetgurad		
Fuel Tank	60 gal. between frame rails, fuel door with thumb latch		
Fuel Tank	Include fuel fill door & sender access plate at interior floor		
High/low Idle Throttle	Electronic		
Instruments	Speedometer, Voltmeter, Oil pressure, Dual air gauges		
Instruments	Transmission temperature gauge, fast idle switch		
Instruments	Air filter restriction indicator, cruise control		
Wheel Chair Lift	Ricon Model S - Series S5510, 1000lb capacity Titanium Line		
Lift Location	Rear		
Lift Specifications	Automatic Positioning at Floor Level with single door		
Shocks	Front and Rear		
Springs, front	3 leaf parabolic front springs comenserate with GVWR		
Suspension	Comfort trac 52" rear springs with 21,000 lbs. rating		
Starting aid	Grid heater		
Steering wheel	Tilt and telescopic steering column		
Tires	Seven (7) 11R22.5 16 ply, Michelin, mounted spare		

Tow hooks	Front and rear mounted		
Transmission	Allison 2500 Series or greater 5 speed, transynd fluid & fuel sense		
Wheel Base	252" or greater (list exact wheelbase)		
Wheels	Disc hub piloted, 22.5 X 8.25 powder coated black		
Wiring	Color & number coded-full multiplex body and chassis		
Warranty-Engine/Trans	5 year engine and transmission warranties		
<b>BODY</b>	<b>BODY</b>		
Access Panels	Located above windshield and driver, access without tools		
Air Conditioning System	Min. 16,000 BTU. Must be able to keep bus cool w/ copy of complete list of A/C parts		
Body Mounts	Meet state and federal specifications		
Child Reminder	Passenger advisory system (not in side panel)		
Crossarm	Electric Operated polycarbonate		
Defroster fans	Dual 6" dash mounted fans		
Door, emergency	upper & lower tinted glass		
Door, entrance	Three position air outward opening with vandaloek		
Directional Front	Turn signals integrated into headlights		
Driver Arm Rests	Dual folding		
Header Storage	Safety Compartment in front header and over driver window		
Emergency exits	4 - push out windows w/ buzzers		
Emergency exits	2 - roof hatches, to be Specialty Pro Lo 9000 or Spheros equivalent		
Flooring	Black floor covering and Koroseal pebble entrance steps		
Flooring	1/2" or greater plywood with metal aisle trim		
Flooring	Rubber over wheelhousings		
Headroom	77 inches, minimum		
Headlining	Acoustic headlining full length of bus		
Heaters	190,000 BTU front & rear combination w/ removable filter		
Heaters	Booster pump and stepwell heater 30,000 BTU's min.		
Heaters	Heater cut off valve(s)		
Identification	6" Black letters, both sides/6" numbers-four sides		
Identification	3/4" x 3" yellow right side rear bumper showing year model		
Insulation	Insulation in roof, front, rear, and side walls. R value = 5.7		
Insulation	1/2" sound absorbing foam installed under driver toeboard		

Lights	Dome lights to have dual rows with driver dome light		
Lights	Halogen or LED headlights with daytime running light feature		
Lights	Warning lights to be LED		
Lights	Marker, stop, tail directional, reverse, side lights to be LED		
Lights	Headlights (wig-wag) when red lights are activated		
Mirrors	Interior - 10" X 30" non-glare with visor, heated crossview		
Mirrors	Roscoe accustyle or open view-remote & heated with 15 minute timer		
Mud Flaps	Front and Rear		
Paint	Yellow body with white roof, black rub rails and black or yellow pilasters		
Parts Report	Copy of complete Bus Parts printout "on-line" no charge		
Reflective Tape	"SCHOOL BUS" front and rear caps to be reflective		
Reflective Tape	Side pushout windows and 2" rear of bus, 2" sides		
Reflectors	To be mechanically attached		
Roof Bows	One piece		
Rub rails	Provide four rubrails, painted black		
Radio	AM/FM/CD or MP3/Page/ 6 int. speakers, 1 ext. speaker		
Radio Speakers	Coaxial Speakers TBB-152991 or equivalent		
Safety	Fire Ext, Body Fluid kit, Flares, First Aid Kit, Seat Belt Cutter		
Safety Compartment	FE, FAK, BFK to be mounted in bulk head compartment or behind driver's seat		
Seat Frames	Frames to be powder coated, black		
Seat Space	24" minimum knee space, include seat plan drawing		
Seat Barriers	Blue fire block, kick panel-right side, storage pouch-left side		
Seats / Driver	Air ride, pedestal cover, 2 shocks, fabric insert		
Seats / Driver	Lap/shoulder belt (orange) with warning indicator, adjustable back		
Seats / Passenger	Seats 6 - 39" Tract MTD and 9 - 30" 6 Tract MTD		
Seats and Belts	Safeguard Safety Seats W/ 3 Point Seat Belts (FE200868-4) and Child Restraint		
Seat Upholstry	Blue		
Securement Systems	Sure-Lok retractable Type FE200855S (4 Sets) w/ storage pouches FF612-4C		
Side Panels	Interior - Aluminized steel side walls		
Solenoid	Disconnect all body circuits, 100 amp minimum		
Strobe	Roof mounted Specialty 515-400 with guard or equal		
Stop arm	Transpec 2000 Electric Operated		
System Floor Track	Wheelchair Tract 4 rows continuous in floor & 1 Continuous Track over windows		

System Floor Track	Continuous Four (4) Track System		
System Floor Track	Recessed in Plywood		
Vents	2 - driver's fresh air & static roof vent		
Windows, Passenger	Black frames with 12" openings, tinted glass		
Windows Driver	Double sliding, aluminum sash, tempered		
Windshield	tinted, bonded in place		
Windshield	2 grip handles beside windshield and cowl steps		
Wipers	Intermittent feature on turn signal lever		
Wiring	Color & number coded		
<b>Customer Fuse block</b>	Allows electrical access without using multiplex wiring		
Backing Alarm	112 db required		
Document Holder	To meet State specs		
Switch	Noise suppression switch to be provided		
Lettering	"Summer County Schools" #'s supplied to successful bidder		
Grille	Chrome grille, hood intake plenum, and headlight bezels		
Camera system	Safety Vision - Please see attachment - Rep. Frank Bowden for proper installation		
Fenders	Rubber or metal fenders around rear wheel opening		
Radio-two way model	JX-5800K-SCPKG-25 Phase I and Phase II and all accessories Contact @ 615-889-4756 for installation and price		
Keys	All units to have common key		
Battery Box	Shall be frame mounted with battery cut off switch in box		

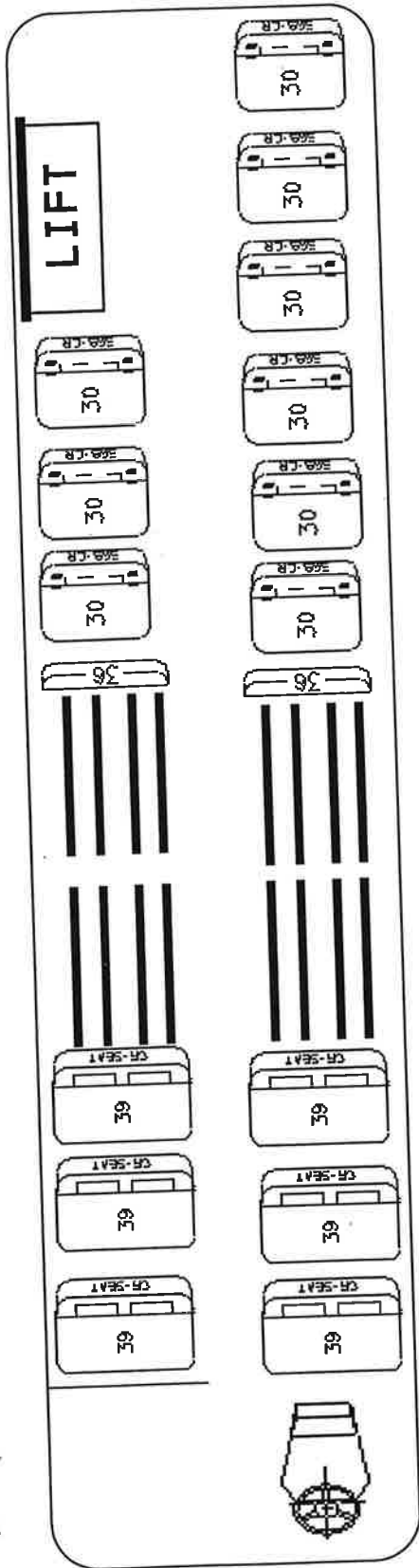

**CHILD RESTRAINT SEATS**



**STD/DOT SEATS**

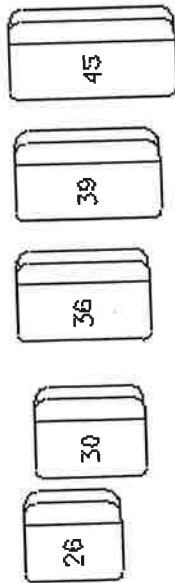

**CEW STUDENT SAFETY CR**

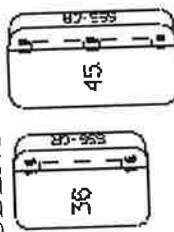

**BARRIERS**

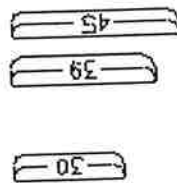

**CEW STUDENT SAFETY**

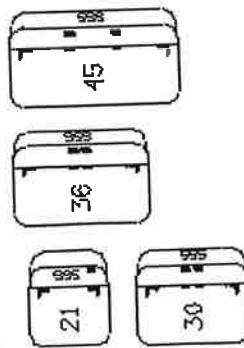

**WHEELCHAIR**

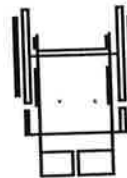

**HATCH**



**TRACK**

TRACK \*

**STROBE**



Safety Vision  
 6100 W. Sam Houston Pkwy.  
 Houston, TX 77041  
 Direct: 713-896-6600  
 Fax: 713-896-6640



Thank you for your request for proposal  
 If you have any questions or issues, just call  
 us TOLL FREE at 1-800-880-8855

41-WS-BRKT	front windshield bracket
SVS-15MMF	15m M/F THREADED CABLE
SVS-10MMF	10m M/F THREADED CABLE
SVS-5MMF	5m M/F THREADED CABLE
AHD-WV	AHD Wide View Camera
AHD-2.8M-WT	2.8mm camera for 4000
Internal Cameras	
SV-EXT8-1080S	AHD curb side 8MM camera for 4100 & 4112 HVR
SV-EXT16-1080S	AHD curb side 16MM camera for 4100 & 4112 HVR
External Cameras	
SV-DECAL	Audio & Video Recording in Progress
41-UPS	UPS back-up battery for the 4000-HVR, 4100-HVR & 4112-HVR
4108-USB	3ft usb a to b
41-PANIC-CABLE	Cable for 41-Panic. Use with all but the 4000HVB
41-PANIC	Panic Button for 4108/4112/4116
41-PANIC-KIT	Panic Button Kit for 41's
SV-BATTERY-AAA	Alkaline AAA Battery
4112-HVR	12 chan rec-8 analog 4 IP cam
4112-1TB-HDD	1 TB hard drive
41-TRIGGER	Trigger Harness for 41 Series
41-PWRHRNS	Power Harness 4000/4100/4108/4112/4116
41-GPS	GPS Module for 41 Series
4112-HVR-1TBHDD	4112-HVR Kit With Standard 1TB Hard Drive.
2 External Cameras / 5 Internal Cameras	
Stop Arm Camera Solution	

**RICON TITANIUM LINE**

**S-SERIES® LIFT: Models: S2005-S5510**

Rated Load Capacity: Up to 1000 lbs. / 454 kg\*  
 Lift Weight: Approx. 400 - 425 lbs. / 181 - 193 kg  
 Power: Electro-Hydraulic  
 Hydraulic Cylinders: (2) each 1.5" Power-Up / Gravity Down  
 Motor Rating @ 12V DC: 65 amp avg. / cycle 1750 psi  
 Manual Backup (up): Hand Pump  
 Manual Backup (down): Pressure Release Valve

\* Requires vehicle specific application engineering. Not intended for retrofit.

MODEL	Stationary Frame Width	Height (folded)	Installation Depth (folded)	Usable Platform Width	Usable Platform Length	Floor-to-Ground Travel	Traveling Frame Width	Clear Entry Width
A	B	C	D	E	F	G	H	
S2005	47/1194	54/1372	14/356	32/813	51/1295	42/1067	40.5/1029	32/813
S2010	49/1245	57/1448	14/356	34/864	54/1372	42/1067	42.5/1080	34/864
S5505	47/1194	57.5/1461	15/381	32/813	51/1295	51/1295	41/1041	32/813
S5510	49/1245	57.5/1461	15/381	34/864	54/1372	51/1295	43/1092	34/864

Dimensions Inches/Millimeters

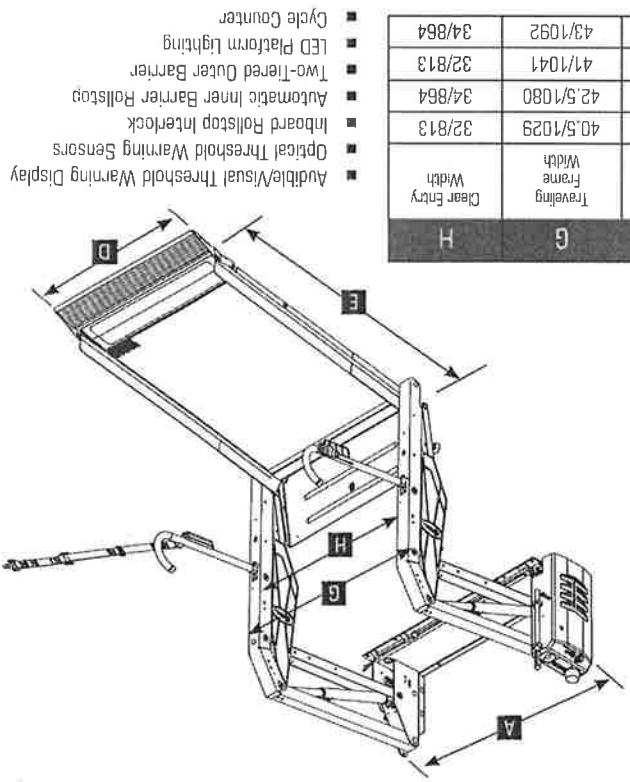

- Audible/Visual Threshold Warning Display
- Optical Threshold Warning Sensors
- Inboard Rollstop Interlock
- Automatic Inner Barrier Rollstop
- Two-Tiered Outer Barrier
- LED Platform Lighting
- Cycle Counter

Rated Load Capacity: Up to 1,000 lbs. / 454 kg\*  
 Lift Weight: Approx. 400-425 lbs. / 181 - 193 kg  
 Power: Electro-Hydraulic  
 Hydraulic Cylinders: (2) each 1.5" Power-Up / Gravity Down  
 Motor Rating @ 12V DC: 65 amp avg. / cycle 1750 psi  
 Manual Backup (up): Hand Pump  
 Manual Backup (down): Pressure Release Valve

\* Requires vehicle specific application engineering. Not intended for retrofit.

MODEL	Stationary Frame Width	Height (folded)	Installation Depth (folded)	Usable Platform Width	Usable Platform Length	Floor-to-Ground Travel	Traveling Frame Width	Clear Entry Width
A	B	C	D	E	F	G	H	
K2005	47/1194	54/1372	16.5/419	31/787	51/1295	37/940	40.5/1029	31.25/794
K2010	49/1245	54/1372	16.5/419	33/838	54/1372	37/940	42.5/1080	33.75/857
K5505	47/1194	57.5/1461	17.5/445	31/787	51/1295	48/1219	41/1041	31.25/794
K5510	49/1245	57.5/1461	17.5/445	33/838	54/1372	48/1219	43/1092	33.75/857

Dimensions Inches/Millimeters

- Audible/Visual Threshold Warning Display
- Optical Threshold Warning Sensor
- Inboard Rollstop Interlock
- Automatic Inboard Rollstop
- Two-Tiered Outer Barrier
- LED Platform Lighting
- Cycle Counter

